

1

2

3

4

5

6

Module 1 6 Hours

Module 2 6 Hours

Module 3 6 Hours

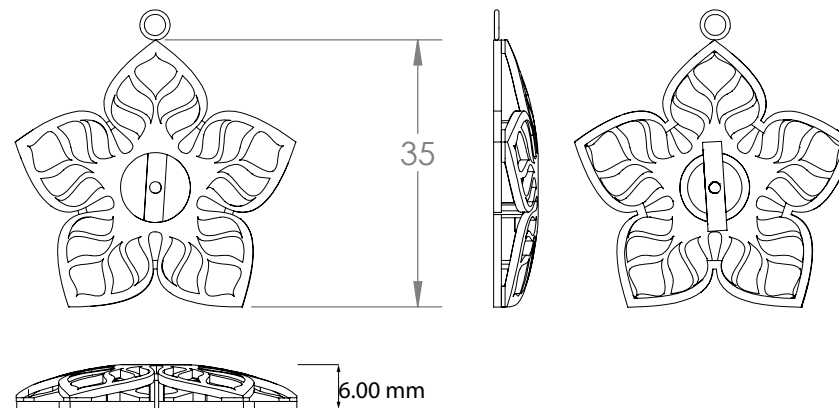
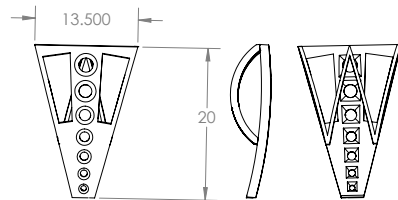
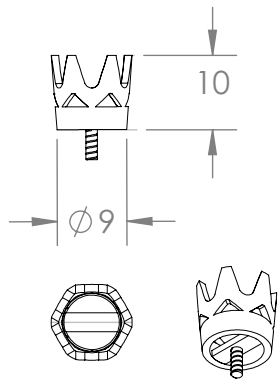

Module 4 4 Hours

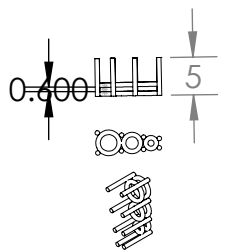

2.50 mm 5.00 mm

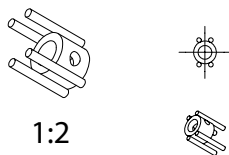

1:2

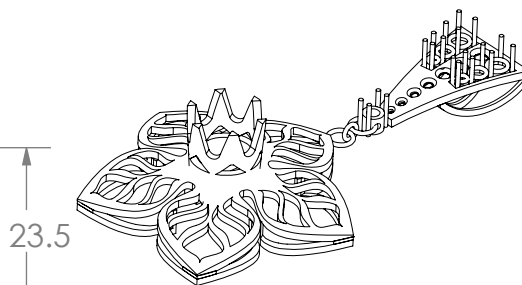
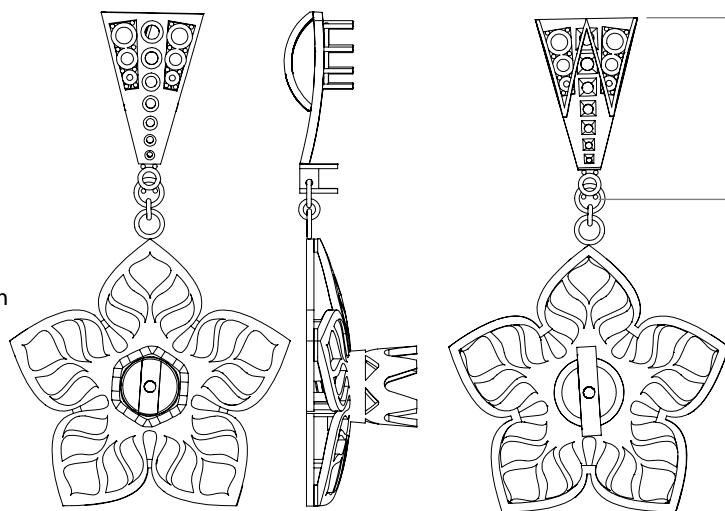

23.5



Test Project for the 43rd WorldSkills
Competition in São Paulo, Brazil 2015.
Copyright © 2015 WorldSkills International.
All Rights Reserved.



Skill: Jewellery Skill 27

Scale: 1:1

Date: 04.05.2015

Paper: A4

Drawn / Design by: Mr. Sidharth Arora

Drawing No: WSC2015_TP27_IN_EN

Description: 22 hr Module test project

Rev: 1

Page: 1 of 1

Appd:

Sign:

1

2

3

4

5

6